

DESCRIPTION

- ELECTRONIC BALLAST
- ELECTRONIC TRANSFORMER
- SWITCH MODE POWER SUPPLY

FEATURES:

- LOW THERMAL RESISTANCE
- HIGH INPUT RESISTANCE
- FAST SWITCHING
- ROHS COMPLIANT

MAXIMUM RATINGS (T_c=25°C)

PARAMETER	SYMBOL	VALUE	UNIT
Drain-source Voltage	VDS	600	V
gate-source Voltage	VGS	±30	V
Continuous Drain Current (T _C =25°C)	ID	4	A
Drain Current-Pulsed	IDM	16	A
Total Dissipation	PD	80	W
Junction Temperature	T _j	150	°C
Storage Temperature	T _{stg}	-55-150	°C
Single Pulse Avalanche Energy	EAS	128	mJ

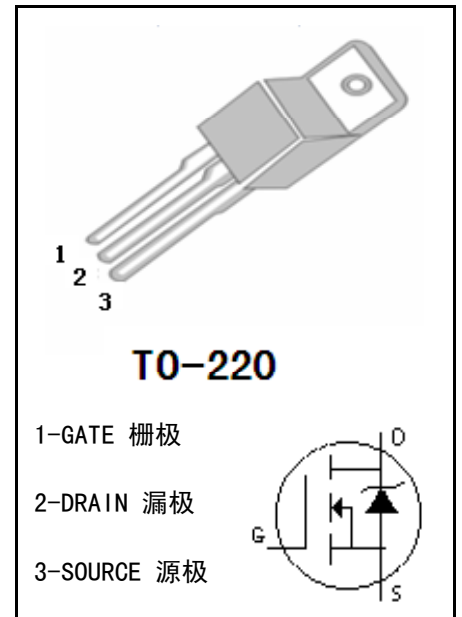
MECHANICAL

ELECTRONIC CHARACTERISTICS (T_c=25°C)

CHARACTERISTICS	SYMBOL	TEST CONDITION	MIN	MAX	UNIT
Drain-source Breakdown Voltage	BVDSS	VGS=0V, ID=250 μA	600		V
Gate Threshold Voltage	VGS (TH)	VGS=VDS, ID=250 μA	2	4	V
Drain-source Leakage Current	IDSS	VDS=600V, VGS=0V		25	uA
Drain-Source Diode Forward Voltage	VSD	VGS=0V, IS=4A		1.4	V
Gate-body Leakage Current (VDS = 0)	IGSS	VGS=±30V		±100	nA
Forward Transconductance	gfs	Vds=10V Id=2.0A	1		S
Static Drain-source On Resistance	RDS (ON)	VGS=10V, ID=2.0A		2.5	Ω
Thermal Resistance Junction-case	RthJ-c			2.5	°C/W

■ DYNAMIC CHARACTERISTICS (T_c=25°C)

CHARACTERISTICS	SYMBOL	TEST CONDITION	MIN	TYP	MAX	UNIT
Input Capacitance	C _{iss}	V _{DS} =25V, V _{GS} =0V, f=1.0MHz	-	610	-	pF
output Capacitance	C _{oss}		-	70	90	pF
Reverse Transfer Capacitance	C _{rss}		-	8	11	pF

■ SWITCHING CHARACTERISTICS (T_c=25°C)

CHARACTERISTICS	SYMBOL	TEST CONDITION	MIN	TYP	MAX	UNIT
Turn-On Delay Time	t _{d(on)}	V _{DD} =300V, I _D =4.0A, R _G =25Ω	-	13	35	ns
Turn-On Rise Time	t _r		-	45	100	ns
Turn-Off Delay Time	t _{d(off)}		-	20	60	ns
Turn-Off Rise Time	t _f		-	35	80	ns
Total Gate Charge	Q _g	V _{DS} =480V, I _D =4.0A, V _{GS} =10V	-	13.3	-	nC
Gate-Source Charge	Q _{gs}		-	4.1	-	nC
Gate-Drain Charge	Q _{gd}		-	2.8	-	nC

■ DRAIN-SOURCE DIODE MAXIMUM RATINGS AND CHARACTERISTICS (T_c=25°C)

CHARACTERISTICS	SYMBOL	TEST CONDITION	MIN	TYP	MAX	UNIT
Max. Diode Forward Current	I _S		-	-	4	A
Max. Pulsed Forward Current	I _{SM}		-	-	16	A
Diode Forward Voltage	V _{SD}	V _{GS} =0V, I _S =4.0A	-	-	1.4	V
Reverse Recovery Time	t _{rr}	V _{GS} =0V, I _S =4.0A, dI _F /dt=100A/μs	-	390	-	ns
Reverse Recovery Charge	Q _{rr}		-	1.5	-	μC



CHARACTERISTICS CURVE

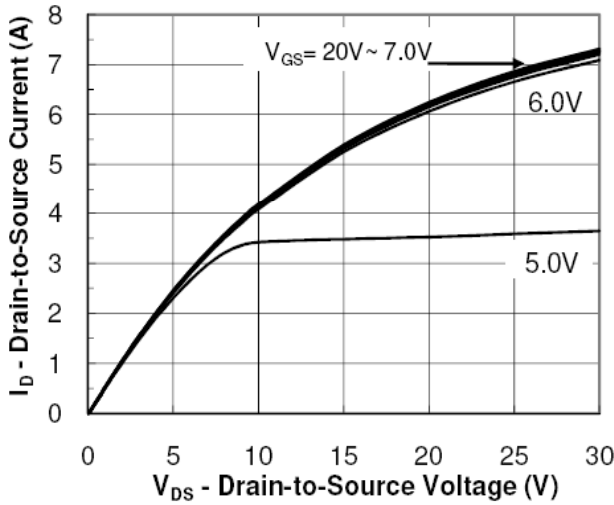

Output Characteristic

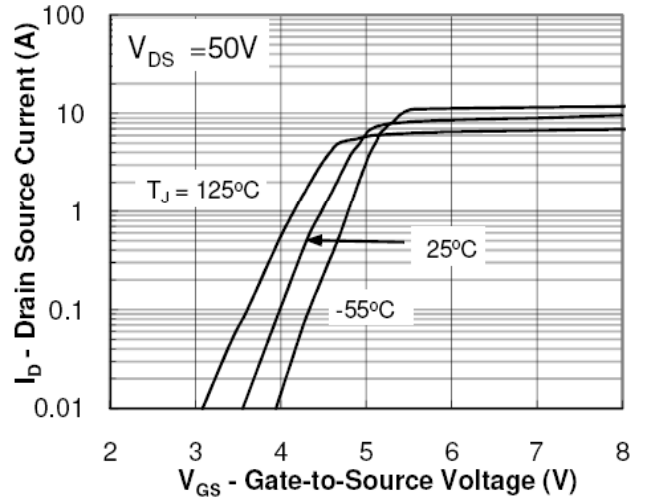

Transfer Characteristic

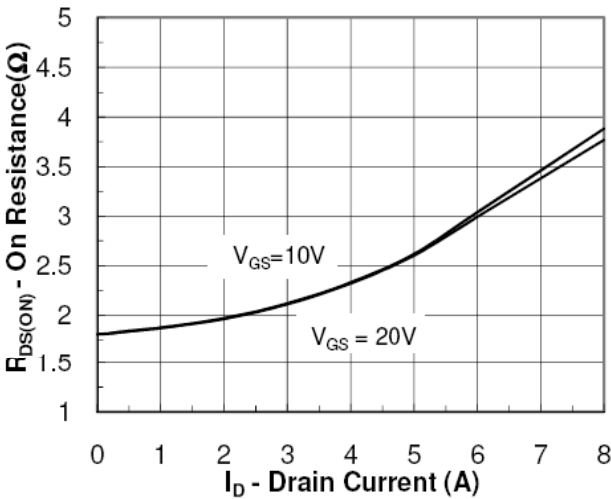

On Resistance Vs Drain Current

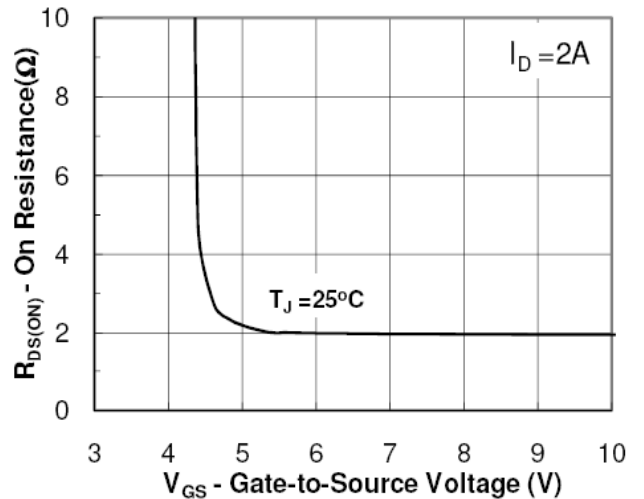

On Resistance Vs Gate Source Voltage

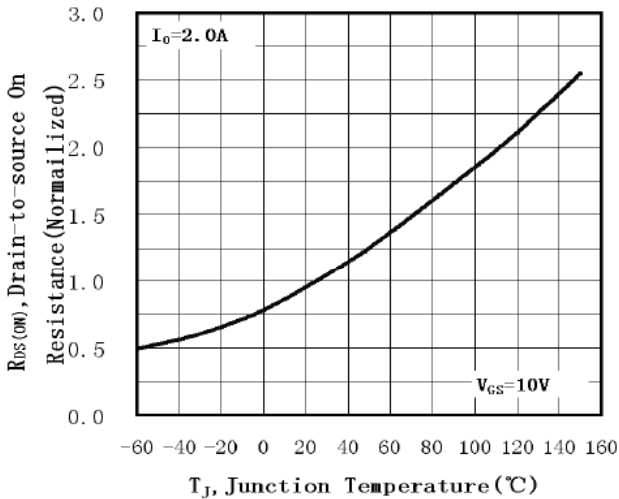

On Resistance Vs Junction Temperature

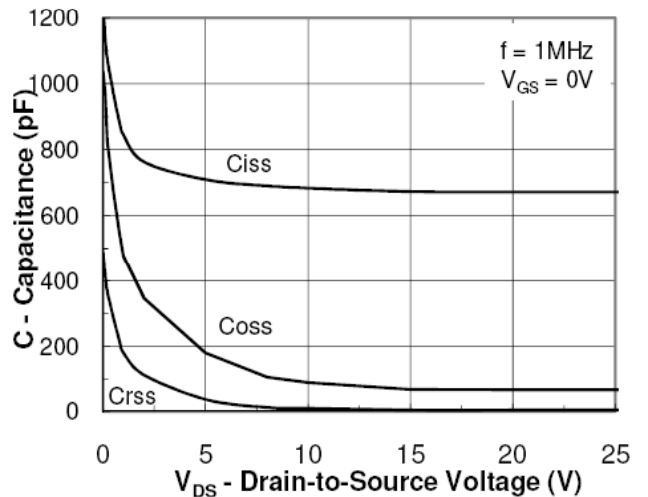

Capacitance



CHARACTERISTICS CURVE

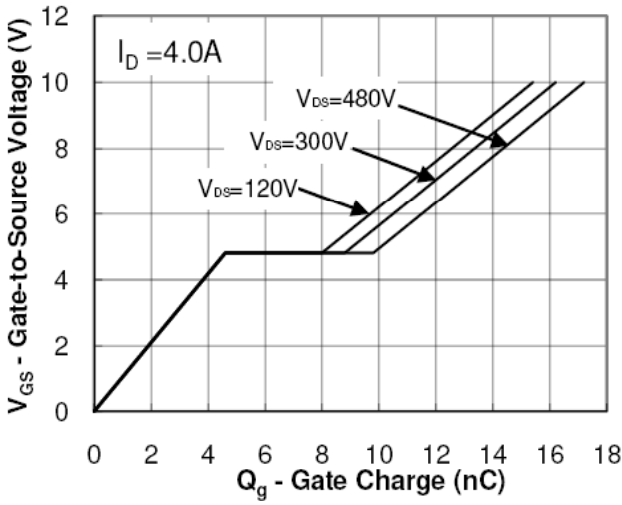

Gate Charge Waveform

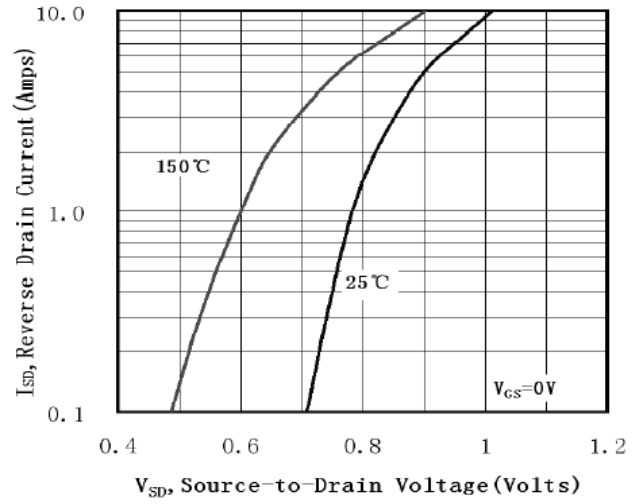

Source-Drain Diode Forward Voltage

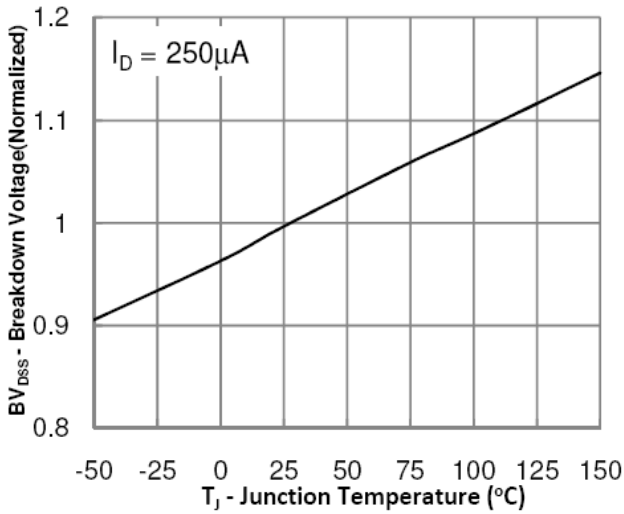

Breakdown Voltage Vs Junction Temperature

TO-220 MECHANICAL DATA

UNIT: mm

SYMBOL	MIN	NOM	MAX	SYMBOL	MIN	NOM	MAX
A	4		4.8	e	2.44	2.54	2.64
B	1.2		1.4	F	1.1		1.4
B1	1		1.4	L	12.5		14.5
b1	0.75		0.95	L1	3	3.5	4
c	0.4		0.55	ΦP	3.7	3.8	3.9
D	15		16.5	Q	2.5		3
D1	5.9		6.9	Q1	2		2.9
E	9.9		10.7				

